

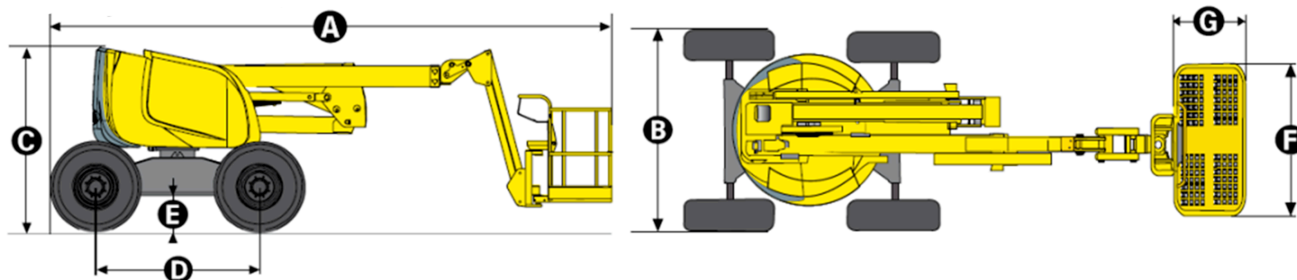









BRAZOS ARTICULADOS TODOTERRENO



✉ departamentocomercial@gerpasa.com

☎ 962 240 988

☎ 660 809 799

							
Modelo	Haulotte HA12PX	Haulotte HA16PX	JLG 450AJ	Haulotte HA16 RTJ	Haulotte HA18PX	Sinoboom AB16EJ PLUS	Haulotte HA20PX
Altura de trabajo	12,40 mts.	16,00 mts.	15,72 mts.	16,00 mts.	17,30 mts.	17,70 mts.	20,65 mts.
Capacidad máxima (Kg)	230 Kg	230 Kg	250 Kg	230 Kg	230 Kg	230 Kg	230 Kg
Peso total máquina (Kg)	5.620 Kg	6.950 Kg	6.495 Kg	6.200 Kg	8.050 Kg	7.300 Kg	11.710 Kg
Largo plataforma (A)	5,50 mts.	6,95 mts.	6,58 mts.	6,75 mts.	7,60 mts.	6,80 mts.	8,93 mts.
Ancho plataforma (B)	1,90 mts.	2,30 mts.	2,35 mts.	2,30 mts.	2,30 mts.	1,90 mts.	2,38 mts.
Altura replugada (C)	2,20 mts.	2,30 mts.	2,27 mts.	2,30 mts.	2,30 mts.	2,00 mts.	2,67 mts.
Distancia entre ejes (D)	1,92 mts.	2,00 mts.	2,36 mts.	2,10 mts.	2,00 mts.	1,90 mts.	2,80 mts.
Altura al suelo (E)	0,26 mts.	0,40 mts.	0,40 mts.	0,38 mts.	0,40 mts.	0,22 mts.	0,42 mts.
Largo cesta (F)	1,50 mts.	1,80 mts.	1,83 mts.	1,83 mts.	1,80 mts.	1,45 mts.	1,80 mts.
Ancho cesta (G)	0,80 mts.	0,80 mts.	0,76 mts.	0,80 mts.	0,80 mts.	0,85 mts.	0,80 mts.
Punto de articulación	5,70 mts.	6,60 mts.	7,30 mts.	7,65 mts.	6,60 mts.	7,80 mts.	6,80 mts.
Alcance horizontal	6,60 mts.	9,15 mts.	7,62 mts.	8,30 mts.	10,60 mts.	9,30 mts.	13,50 mts.





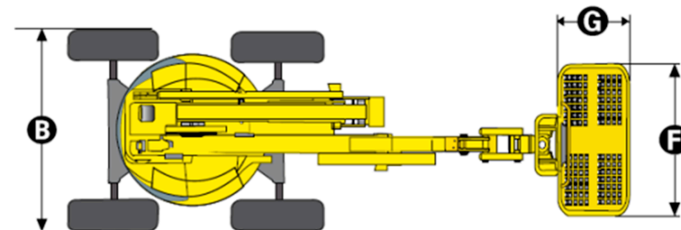
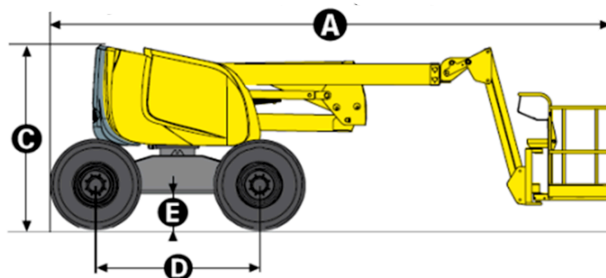

BRAZOS ARTICULADOS TODOTERRENO



✉ departamentocomercial@gerpasa.com

☎ 962 240 988

☎ 660 809 799

				
Modelo	Sinoboom AB22EJ PLUS	Haulotte HA26PX	Haulotte HA32PX	Haulotte HA41PX
Altura de trabajo	23,6 mts.	25,60 mts.	31,80 mts.	41,50 mts.
Capacidad máxima (Kg)	230 Kg	230 Kg	230 Kg	250 Kg
Peso total máquina (Kg)	10.900 Kg	15.950 Kg	21.100 Kg	23.100 Kg
Largo plataforma (A)	9,95 mts.	12,00 mts.	11,16 mts.	12,80 mts.
Ancho plataforma (B)	2,49 mts.	2,35 mts.	2,50 mts.	2,50 mts.
Altura replegada (C)	2,68 mts.	2,67 mts.	2,70 mts.	2,99 mts.
Distancia entre ejes (D)	2,49 mts.	2,80 mts.	3,50 mts.	3,50 mts.
Altura al suelo (E)	0,39 mts.	0,42 mts.	0,38 mts.	0,38 mts.
Largo cesta (F)	2,44 mts.	1,80 mts.	2,44 mts.	2,44 mts.
Ancho cesta (G)	0,91 mts.	0,80 mts.	0,80 mts.	0,80 mts.
Punto de articulación	8,9 mts.	6,80 mts.	11,35 mts.	17,34 mts.
Alcance horizontal	13,40 mts.	16,20 mts.	21,30 mts.	19,80 mts.









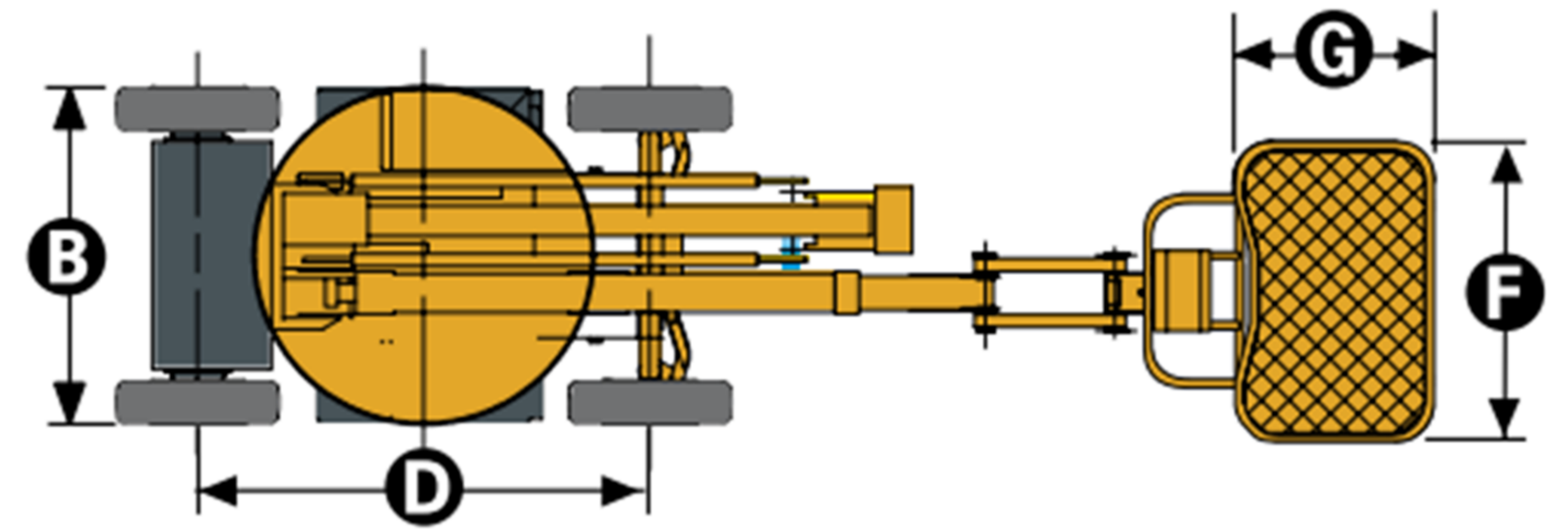
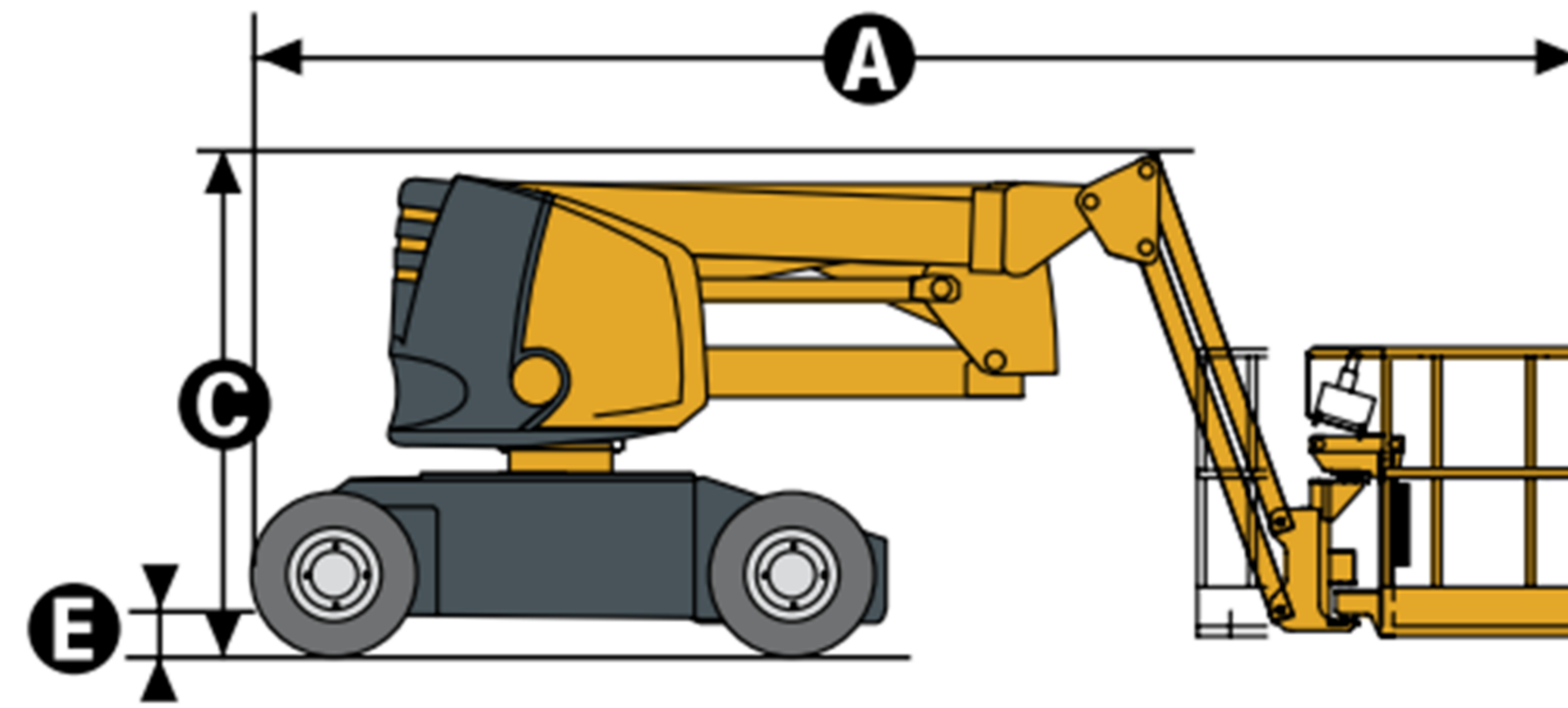

BRAZOS ARTICULADOS ELECTRICOS

✉ departamentocomercial@gerpasa.com

☎ 962 240 988

☎ 660 809 799



							
Modelo	Genie Z-30/20N RJ	JLG E300AJP	Haulotte HA12 CJ	Haulotte HA12 IP	JLG E400AJPN	Haulotte HA15 I	Haulotte HA15 IP
Altura de trabajo	10,89 mts.	10,97 mts.	11,68 mts.	12,00 mts.	14,19 mts.	15 mts.	15,87 mts.
Capacidad máxima (Kg)	227 Kg	230 Kg	250 Kg	230 Kg	230 Kg	265 Kg	230 Kg
Peso total máquina (Kg)	6.605 Kg	7.100 Kg	7.065 Kg	5.900 Kg	6.850 Kg	6.600 Kg	7.230 Kg
Largo plataforma (A)	5,31 mts.	5,74 mts.	5,36 mts.	5,45 mts.	6,71 mts.	5,77 mts.	6,65 mts.
Ancho plataforma (B)	1,19 mts.	1,22 mts.	1,20 mts.	1,35 mts.	1,50 mts.	1,50 mts.	1,52 mts.
Altura replegada (C)	2,00 mts.	2,01 mts.	1,99 mts.	2,00 mts.	1,97 mts.	1,97 mts.	2,10 mts.
Distancia entre ejes (D)	1,58 mts.	1,65 mts.	1,65 mts.	2,00 mts.	2,01 mts.	2,00 mts.	2,00 mts.
Altura al suelo (E)	0,09 mts.	0,10 mts.	0,107 mts.	0,15 mts.	0,13 mts.	0,13 mts.	0,14 mts.
Largo cesta (F)	0,76 mts.	1,22 mts.	1,14 mts.	1,20 mts.	1,22 mts.	1,20 mts.	1,15 mts.
Ancho cesta (G)	1,17 mts.	0,76 mts.	0,80 mts.	0,80 mts.	0,76 mts.	0,76 mts.	0,80 mts.
Punto de articulación	3,86 mts.	4,01 mts.	4,74 mts.	5,25 mts.	6,55 mts.	6,50 mts.	6,25 mts.
Alcance horizontal	6,53 mts.	6,12 mts.	6,94 mts.	6,60 mts.	6,83 mts.	7,70 mts.	8,45 mts.



BRAZOS ARTICULADOS ELECTRICOS



✉ departamentocomercial@gerpasa.com

☎ 962 240 988

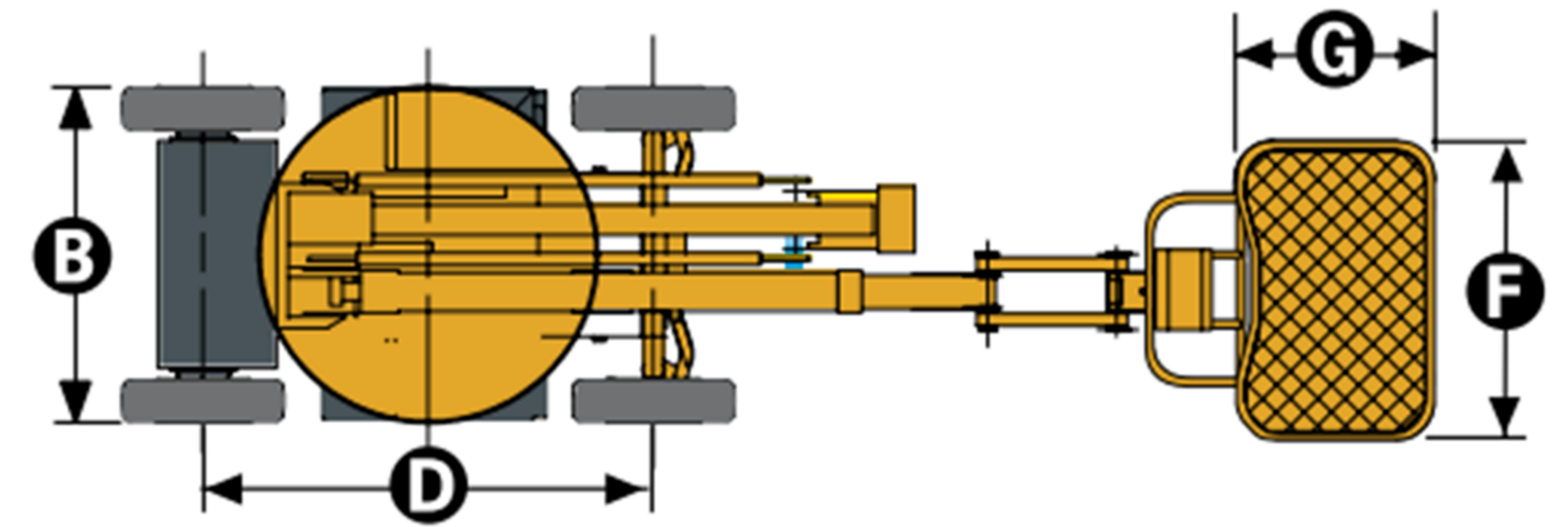
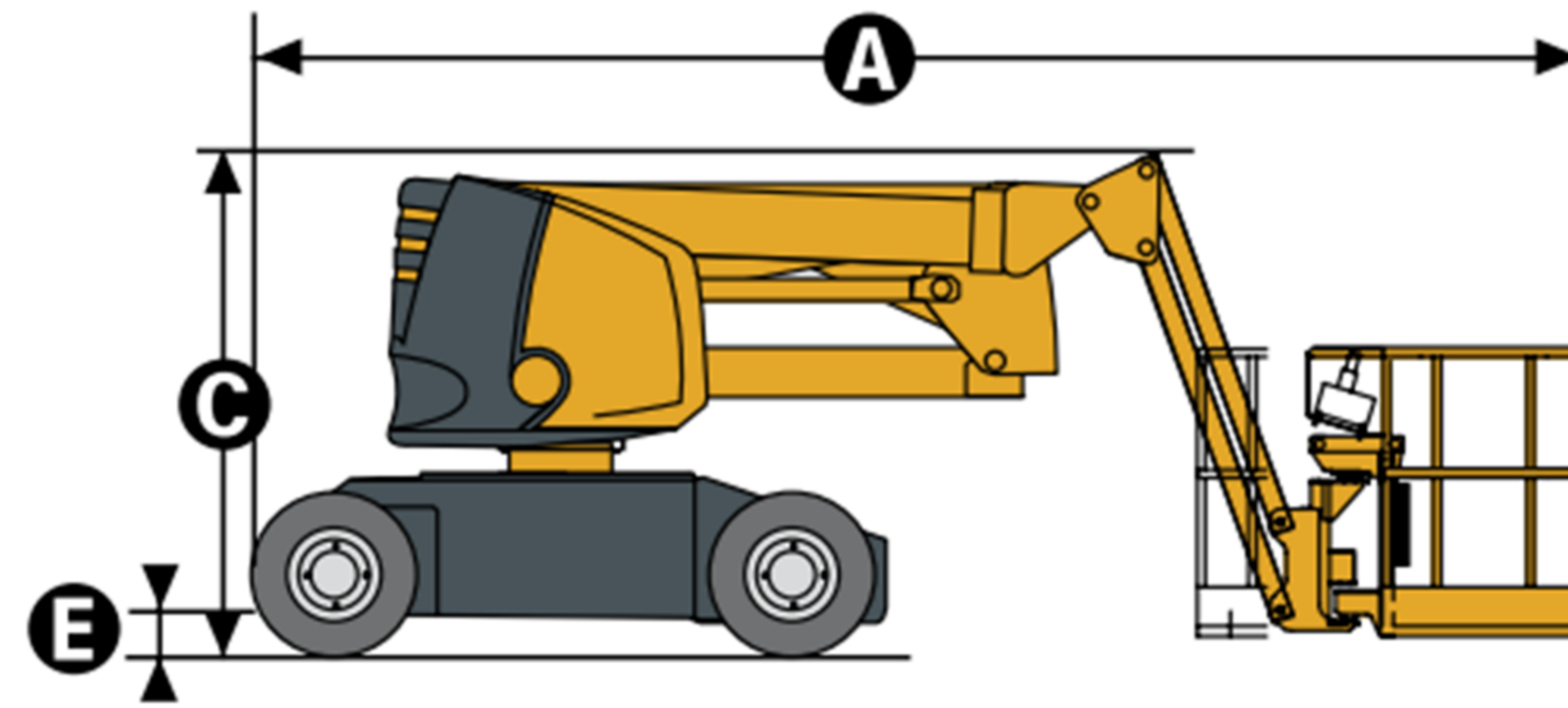
☎ 660 809 799



Estos modelos de brazos eléctricos vienen equipados con ruedas de obra que les permite trabajar en exterior

Modelo			
Altura de trabajo	15,72 mts.	17,70 mts.	23,60 mts.
Capacidad máxima (Kg)	230 Kg	230 Kg	230 Kg
Peso total máquina (Kg)	6.670 Kg	7.300 Kg	10.900 Kg
Largo plataforma (A)	6,45 mts.	6,80 mts.	9,95 mts.
Ancho plataforma (B)	1,75 mts.	1,90 mts.	2,49 mts.
Altura replegada (C)	2,10 mts.	2,00 mts.	2,68 mts.
Distancia entre ejes (D)	2,01 mts.	1,90 mts.	2,49 mts.
Altura al suelo (E)	0,20 mts.	0,22 mts.	0,39 mts.
Largo cesta (F)	1,52 mts.	1,83 mts.	2,44 mts.
Ancho cesta (G)	0,76 mts.	0,85 mts.	0,91 mts.
Punto de articulación	7,89 mts.	7,80 mts.	8,90 mts.
Alcance horizontal	7,24 mts.	9,30 mts.	13,40 mts.